

# Canale

## TONDA RICCIOLO GRANDE S09

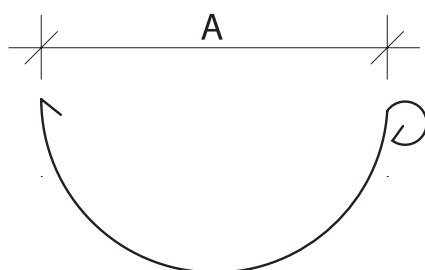

| Sviluppo | A   | RAME 6/10                           | TM 6/10                  | INOX 6/10                | ZINC. 6/10               |
|----------|-----|-------------------------------------|--------------------------|--------------------------|--------------------------|
| 300      | 120 | <input type="checkbox"/>            | <input type="checkbox"/> | <input type="checkbox"/> | <input type="checkbox"/> |
| 330      | 130 | <input checked="" type="checkbox"/> | <input type="checkbox"/> | <input type="checkbox"/> | <input type="checkbox"/> |
| 350      | 150 | <input type="checkbox"/>            | <input type="checkbox"/> | <input type="checkbox"/> | <input type="checkbox"/> |

Ricciolo: Diametro = 20 mm • Sviluppo = 50 mm

## TONDA S10

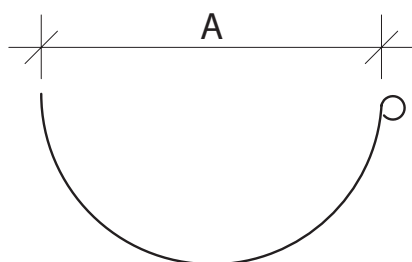

| Sviluppo | A   | RAME 6/10                           | TM 6/10                             | INOX 6/10                           | ZINC. 6/10                          |
|----------|-----|-------------------------------------|-------------------------------------|-------------------------------------|-------------------------------------|
| 250      | 130 | <input checked="" type="checkbox"/> | <input checked="" type="checkbox"/> | <input checked="" type="checkbox"/> | <input checked="" type="checkbox"/> |
| 280      | 140 | <input checked="" type="checkbox"/> | <input checked="" type="checkbox"/> | <input type="checkbox"/>            | <input type="checkbox"/>            |
| 300      | 160 | <input checked="" type="checkbox"/> | <input checked="" type="checkbox"/> | <input checked="" type="checkbox"/> | <input checked="" type="checkbox"/> |
| 330      | 180 | <input checked="" type="checkbox"/> | <input checked="" type="checkbox"/> | <input checked="" type="checkbox"/> | <input type="checkbox"/>            |

Ricciolo: Diametro = 13 mm • Sviluppo = 30 mm

## SAGOMATA S11

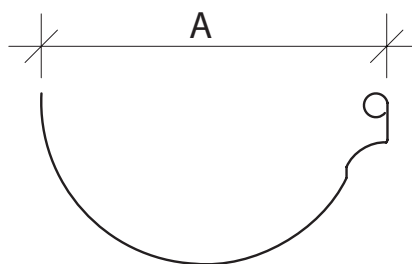

| Sviluppo | A   | RAME 6/10                           | TM 6/10                             | INOX 6/10                           | ZINC. 6/10               |
|----------|-----|-------------------------------------|-------------------------------------|-------------------------------------|--------------------------|
| 300      | 160 | <input checked="" type="checkbox"/> | <input checked="" type="checkbox"/> | <input checked="" type="checkbox"/> | <input type="checkbox"/> |
| 330      | 180 | <input checked="" type="checkbox"/> | <input checked="" type="checkbox"/> | <input checked="" type="checkbox"/> | <input type="checkbox"/> |

Ricciolo: Diametro = 13 mm • Sviluppo = 30 mm

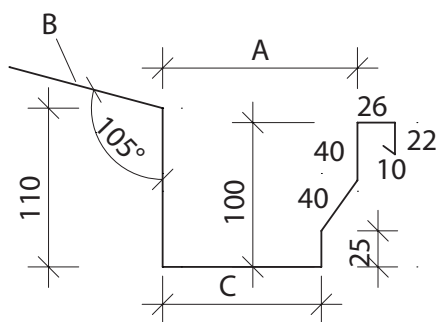

## QUADRA S12

| Sviluppo | A   | B   | C   | RAME 6/10                           | TM 6/10                             | INOX 6/10                | ZINC. 6/10               |
|----------|-----|-----|-----|-------------------------------------|-------------------------------------|--------------------------|--------------------------|
| 400      | 105 | 47  | 80  | <input type="checkbox"/>            | <input type="checkbox"/>            | <input type="checkbox"/> | <input type="checkbox"/> |
| 450      | 125 | 77  | 100 | <input type="checkbox"/>            | <input type="checkbox"/>            | <input type="checkbox"/> | <input type="checkbox"/> |
| 500      | 135 | 117 | 110 | <input checked="" type="checkbox"/> | <input checked="" type="checkbox"/> | <input type="checkbox"/> | <input type="checkbox"/> |

**Materiale e misure diverse sono disponibili a richiesta**

Legenda:  materiale disponibile a magazzino (in lung. 4000 mm)  materiale a richiesta

# Canale

## SEMITONDA CON ALETTA S15

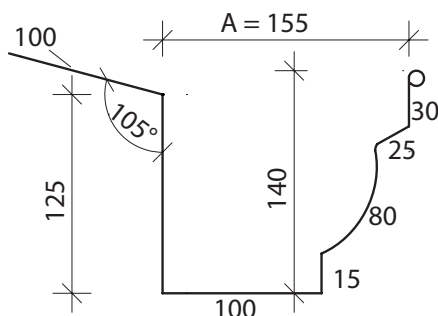

| Sviluppo | A   | RAME 6/10 | TM 6/10 | INOX 6/10 | ZINC. 6/10 |
|----------|-----|-----------|---------|-----------|------------|
| 500      | 155 | ■         | ■       | □         | □          |
|          |     |           |         |           |            |
|          |     |           |         |           |            |
|          |     |           |         |           |            |

Ricciolo: Diametro = 13 mm • Sviluppo = 30 mm

## SEMITONDA S16

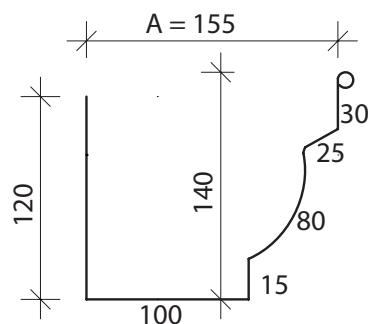

| Sviluppo | A   | RAME 6/10 | TM 6/10 | INOX 6/10 | ZINC. 6/10 |
|----------|-----|-----------|---------|-----------|------------|
| 400      | 155 | ■         | ■       | □         | □          |
|          |     |           |         |           |            |
|          |     |           |         |           |            |
|          |     |           |         |           |            |

Ricciolo: Diametro = 13 mm • Sviluppo = 30 mm

## SAGOMATA CON ALETTA L01

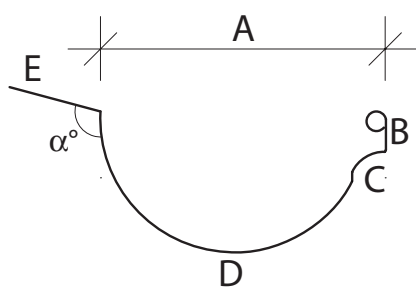

| Sviluppo | Disp. | A   | B  | C  | D   | E  | $\alpha^\circ$ |
|----------|-------|-----|----|----|-----|----|----------------|
| 300      | □     | 160 | 30 | 30 | 210 | 30 | su misura      |
| 400      | □     | 180 | 30 | 30 | 240 | 70 | su misura      |
|          |       |     |    |    |     |    |                |
|          |       |     |    |    |     |    |                |

Ricciolo: Diametro = 13 mm • Sviluppo = 30 mm

## TONDA CON ALETTA L02

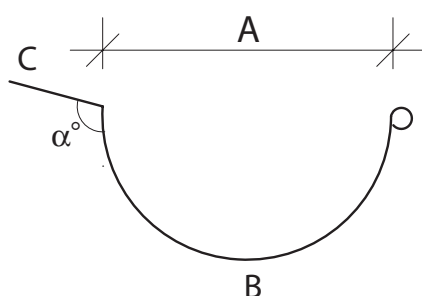

| Sviluppo | A   | B   | C  | $\alpha^\circ$ |
|----------|-----|-----|----|----------------|
| 300      | 130 | 220 | 50 | su misura      |
| 330      | 140 | 250 | 50 | su misura      |
| 400      | 180 | 300 | 70 | su misura      |
|          |     |     |    |                |
|          |     |     |    |                |

Ricciolo: Diametro = 20 mm • Sviluppo = 50 mm

**Materiali e misure diverse sono disponibili a richiesta**

Legenda: ■ materiale disponibile a magazzino (in lung. 4000 mm) □ materiale a richiesta

# Canale

## SAGOMATA TRONCATA Lo3

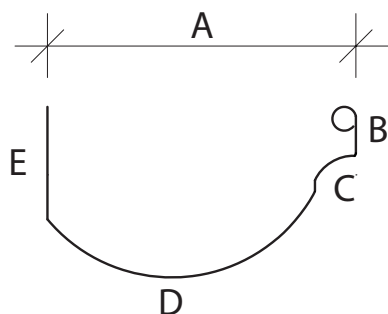

| Sviluppo | Disp.                    | A   | B  | C  | D   | E  |
|----------|--------------------------|-----|----|----|-----|----|
| 330      | <input type="checkbox"/> | 150 | 30 | 30 | 210 | 30 |
| 400      | <input type="checkbox"/> | 175 | 30 | 30 | 250 | 60 |
| 450      | <input type="checkbox"/> | 185 | 30 | 30 | 280 | 80 |

Ricciolo: Diametro = 13 mm • Sviluppo = 30 mm

## SAGOMATA TRONCATA CON ALETTA Lo4

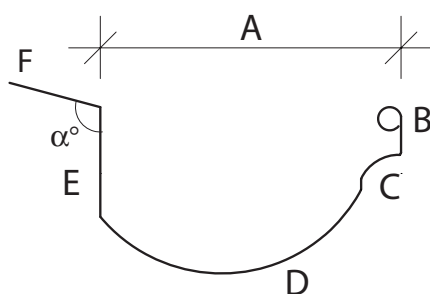

| Sviluppo | Disp.                    | A   | B  | C  | D   | E  | F  | $\alpha^\circ$ |
|----------|--------------------------|-----|----|----|-----|----|----|----------------|
| 400      | <input type="checkbox"/> | 150 | 30 | 30 | 210 | 30 | 70 | su misura      |
| 450      | <input type="checkbox"/> | 175 | 30 | 30 | 250 | 60 | 50 | su misura      |
| 500      | <input type="checkbox"/> | 185 | 30 | 30 | 280 | 80 | 50 | su misura      |

Ricciolo: Diametro = 13 mm • Sviluppo = 30 mm

## SAGOMATA CON BORDO QUADRO Lo5

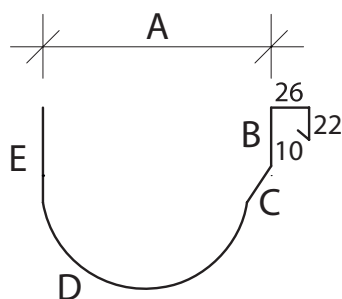

| Sviluppo | Disp.                    | A   | B  | C  | D   | E  |
|----------|--------------------------|-----|----|----|-----|----|
| 400      | <input type="checkbox"/> | 170 | 40 | 30 | 207 | 65 |
| 450      | <input type="checkbox"/> | 195 | 40 | 30 | 257 | 65 |

## SAGOMATA CON BORDO QUADRO E ALETTA Lo6

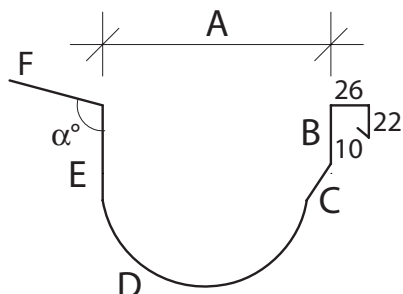

| Sviluppo | Disp.                    | A   | B  | C  | D   | E  | F  | $\alpha^\circ$ |
|----------|--------------------------|-----|----|----|-----|----|----|----------------|
| 450      | <input type="checkbox"/> | 170 | 40 | 30 | 207 | 65 | 50 | su misura      |
| 500      | <input type="checkbox"/> | 195 | 40 | 30 | 257 | 65 | 50 | su misura      |

Ricciolo: Diametro = 20 mm • Sviluppo = 50 mm

**Materiale e misure diverse sono disponibili a richiesta**

Legenda:  materiale disponibile a magazzino (in lung. 4000 mm)  materiale a richiesta

# Canale

## SEMITONDA RICCIO INTERNO L07

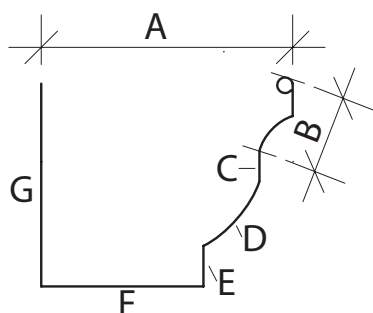

| Sviluppo | Disp. | A   | B  | C  | D  | E  | F   | G   |
|----------|-------|-----|----|----|----|----|-----|-----|
| 450      | □     | 180 | 85 | 30 | 50 | 25 | 110 | 150 |

Ricciolo: Diametro = 13 mm • Sviluppo = 30 mm

## SEMITONDA RICCIO INTERNO CON ALETTA L08

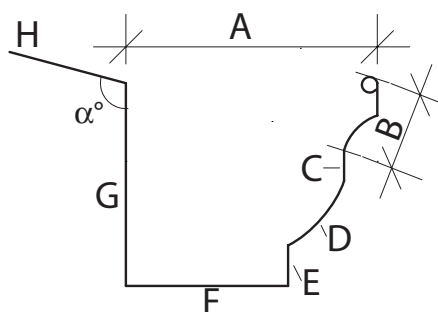

| Sviluppo | Disp. | A   | B  | C  | D  | E  | F   | G   | H  | $\alpha^\circ$ |
|----------|-------|-----|----|----|----|----|-----|-----|----|----------------|
| 500      | □     | 180 | 85 | 30 | 50 | 25 | 110 | 150 | 50 | su misura      |

Ricciolo: Diametro = 13 mm • Sviluppo = 30 mm

## SAGOMATA CON PANCIA E RICCIO INTERNO L09

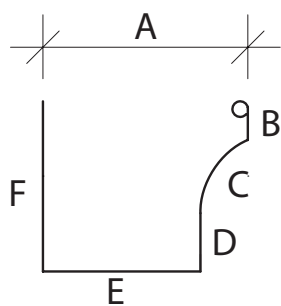

| Sviluppo | Disp. | A   | B  | C  | D  | E   | F   |
|----------|-------|-----|----|----|----|-----|-----|
| 450      | □     | 165 | 30 | 80 | 50 | 110 | 150 |

Ricciolo: Diametro = 13 mm • Sviluppo = 30 mm

## SAGOMATA CON PANCIA E RICCIO INTERNO CON ALETTA L10

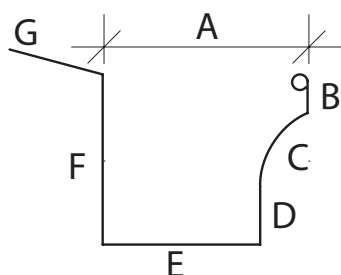

| Sviluppo | Disp. | A   | B  | C  | D  | E   | F   | G  | $\alpha^\circ$ |
|----------|-------|-----|----|----|----|-----|-----|----|----------------|
| 500      | □     | 165 | 30 | 80 | 50 | 110 | 150 | 50 | su misura      |

Ricciolo: Diametro = 13 mm • Sviluppo = 30 mm

**Materiale e misure diverse sono disponibili a richiesta**

Legenda: ■ materiale disponibile a magazzino (in lung. 4000 mm) □ materiale a richiesta

# Canale

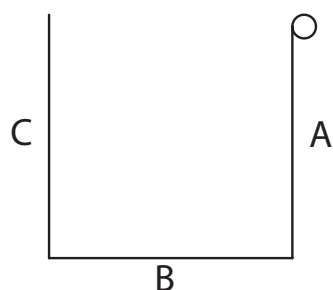

## PROFILO L11

| Sviluppo | Disp.                    | A   | B   | C   |
|----------|--------------------------|-----|-----|-----|
| 250      | <input type="checkbox"/> | 70  | 80  | 70  |
| 300      | <input type="checkbox"/> | 85  | 100 | 85  |
| 330      | <input type="checkbox"/> | 100 | 100 | 100 |
| 400      | <input type="checkbox"/> | 120 | 130 | 120 |
| 500      | <input type="checkbox"/> | 150 | 170 | 150 |

Ricciolo: Diametro = 13 mm • Sviluppo = 30 mm

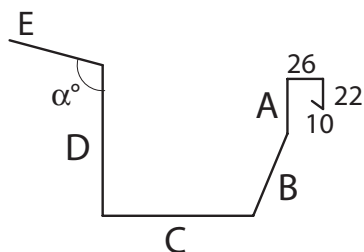

## PROFILO L12

| Sviluppo | Disp.                    | A  | B  | C   | D   | E  | $\alpha^\circ$ |
|----------|--------------------------|----|----|-----|-----|----|----------------|
| 400      | <input type="checkbox"/> | 50 | 55 | 100 | 110 | 37 | su misura      |
| 450      | <input type="checkbox"/> | 60 | 60 | 110 | 120 | 42 | su misura      |
| 500      | <input type="checkbox"/> | 60 | 75 | 120 | 130 | 57 | su misura      |

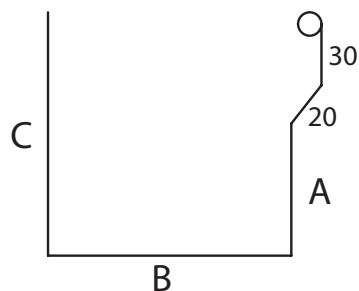

## PROFILO L13

| Sviluppo | Disp.                    | A  | B   | C   |
|----------|--------------------------|----|-----|-----|
| 300      | <input type="checkbox"/> | 40 | 90  | 90  |
| 330      | <input type="checkbox"/> | 50 | 100 | 100 |
| 400      | <input type="checkbox"/> | 65 | 130 | 125 |
| 450      | <input type="checkbox"/> | 90 | 140 | 140 |

Ricciolo: Diametro = 13 mm • Sviluppo = 30 mm

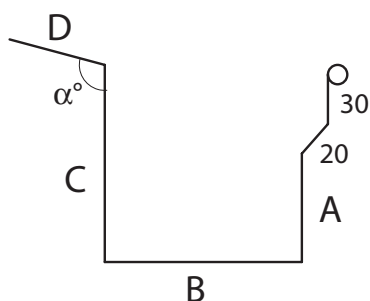

## PROFILO L14

| Sviluppo | Disp.                    | A  | B   | C   | D  | $\alpha^\circ$ |
|----------|--------------------------|----|-----|-----|----|----------------|
| 330      | <input type="checkbox"/> | 40 | 90  | 90  | 30 | su misura      |
| 400      | <input type="checkbox"/> | 50 | 100 | 100 | 70 | su misura      |
| 450      | <input type="checkbox"/> | 65 | 130 | 125 | 50 | su misura      |
| 500      | <input type="checkbox"/> | 90 | 140 | 140 | 50 | su misura      |

Ricciolo: Diametro = 13 mm • Sviluppo = 30 mm

**Materiale e misure diverse sono disponibili a richiesta**

Legenda:  materiale disponibile a magazzino (in lung. 4000 mm)  materiale a richiesta

# Canale

## PROFILO L15

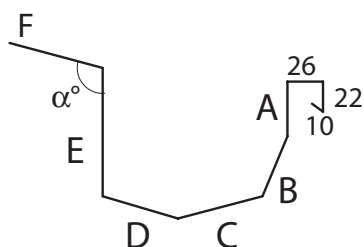

| Sviluppo | Disp.                    | A  | B  | C  | D  | E   | F  | $\alpha^\circ$ |
|----------|--------------------------|----|----|----|----|-----|----|----------------|
| 330      | <input type="checkbox"/> | 40 | 45 | 40 | 40 | 77  | 30 | su misura      |
| 400      | <input type="checkbox"/> | 50 | 55 | 50 | 50 | 97  | 40 | su misura      |
| 450      | <input type="checkbox"/> | 60 | 65 | 60 | 60 | 117 | 30 | su misura      |
| 500      | <input type="checkbox"/> | 65 | 70 | 65 | 65 | 127 | 50 | su misura      |

## PROFILO L16

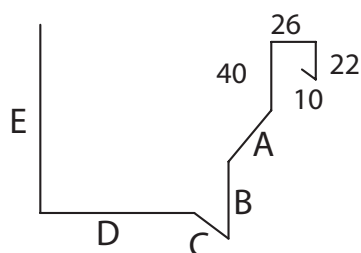

| Sviluppo | Disp.                    | A  | B  | C  | D   | E   |
|----------|--------------------------|----|----|----|-----|-----|
| 400      | <input type="checkbox"/> | 30 | 40 | 20 | 112 | 100 |
| 450      | <input type="checkbox"/> | 45 | 50 | 20 | 120 | 117 |
| 500      | <input type="checkbox"/> | 55 | 60 | 20 | 140 | 127 |

## PROFILO L17

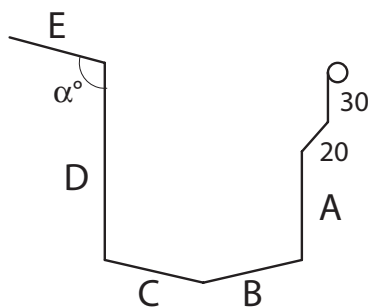

| Sviluppo | Disp.                    | A  | B  | C  | D   | E   | $\alpha^\circ$ |
|----------|--------------------------|----|----|----|-----|-----|----------------|
| 400      | <input type="checkbox"/> | 55 | 55 | 55 | 100 | 55  | su misura      |
| 450      | <input type="checkbox"/> | 55 | 55 | 55 | 100 | 105 | su misura      |
| 500      | <input type="checkbox"/> | 65 | 65 | 65 | 110 | 115 | su misura      |

Ricciolo: Diametro = 13 mm • Sviluppo = 30 mm

**Materiali e misure diverse sono disponibili a richiesta**

Legenda:  materiale disponibile a magazzino (in lung. 4000 mm)  materiale a richiesta